

## Effects of Acute Increases in Left Ventricular Preload on Indices of Myocardial Function in Conscious, Unrestrained and Intact, Tranquilized Baboons

Michael Zimpfer, Stephen F. Vatner

*J Clin Invest.* 1981;67(2):430-438. <https://doi.org/10.1172/JCI110051>.

### Research Article

The effects of acute volume loading were examined on indices of left ventricular (LV) function in conscious, unrestrained and intact, tranquilized baboons. Experiments were conducted 1-3 mo after implantation of ultrasonic transducers to measure LV internal diameter and wall thickness, and miniature LV pressure gauges and aortic and left atrial catheters. In 10 intact, tranquilized baboons, rapid volume loading with saline increased LV end-diastolic pressure by  $23.7 \pm 2.6$  mm Hg, LV end-diastolic diameter by  $7.8 \pm 1.5\%$ , LV stroke work by  $37.5 \pm 7.8\%$ , while mean arterial pressure and peak LV wall stress did not change significantly. Despite the increase in preload and activation of the Frank-Starling mechanism, LV  $dP/dt_{max}$  and the maximum velocity of myocardial fiber shortening ( $LVdD/dt_{max}$ ) did not change. Volume loading after  $\beta$ -adrenergic or combined  $\beta$ -adrenergic and cholinergic blockades or volume loading with blood instead of saline also failed to augment LV  $dP/dt_{max}$  and LV  $dD/dt_{max}$  despite the increase in preload. In order to volume load the baboons in the conscious state, a radiofrequency (RF) interrogator system was devised, which upon receipt of a radio command, activated a battery operated pump to infuse 1,000 ml of saline i.v. to the baboons. In these experiments, preload rose, i.e., LV end-diastolic diameter increased by  $13.9 \pm 2.1\%$  and the Frank-Starling mechanism could be demonstrated, i.e., stroke work rose by  $42.8 \pm 7.4\%$ , but LV  $dP/dt_{max}$  and LV [...]

Find the latest version:

<https://jci.me/110051/pdf>



# Effects of Acute Increases in Left Ventricular Preload on Indices of Myocardial Function in Conscious, Unrestrained and Intact, Tranquilized Baboons

MICHAEL ZIMPFER and STEPHEN F. VATNER, *Departments of Medicine, Harvard Medical School and Peter Bent Brigham Hospital, Boston, Massachusetts; New England Regional Primate Research Center, Southboro, Massachusetts 01772*

**ABSTRACT** The effects of acute volume loading were examined on indices of left ventricular (LV) function in conscious, unrestrained and intact, tranquilized baboons. Experiments were conducted 1–3 mo after implantation of ultrasonic transducers to measure LV internal diameter and wall thickness, and miniature LV pressure gauges and aortic and left atrial catheters. In 10 intact, tranquilized baboons, rapid volume loading with saline increased LV end-diastolic pressure by  $23.7 \pm 2.6$  mm Hg, LV end-diastolic diameter by  $7.8 \pm 1.5\%$ , LV stroke work by  $37.5 \pm 7.8\%$ , while mean arterial pressure and peak LV wall stress did not change significantly. Despite the increase in preload and activation of the Frank-Starling mechanism, LV  $dP/dt_{max}$  and the maximum velocity of myocardial fiber shortening (LV  $dD/dt_{max}$ ) did not change. Volume loading after  $\beta$ -adrenergic or combined  $\beta$ -adrenergic and cholinergic blockades or volume loading with blood instead of saline also failed to augment LV  $dP/dt_{max}$  and LV  $dD/dt_{max}$  despite the increase in preload. In order to volume load the baboons in the conscious state, a radiofrequency (RF) interrogator system was devised, which upon receipt of a radio command, activated a battery operated pump to infuse 1,000 ml of saline i.v. to the baboons. In these experiments, preload rose, i.e., LV end-diastolic diameter increased by  $13.9 \pm 2.1\%$  and the Frank-Starling mechanism could be demonstrated, i.e., stroke work rose by  $42.8 \pm 7.4\%$ , but LV  $dP/dt_{max}$  and LV  $dD/dt_{max}$  did not change. After preload was depressed by hemorrhage, the rapid infusion of either blood or saline increased LV

$dP/dt_{max}$  by  $92.7 \pm 18.5\%$  and LV  $dD/dt_{max}$  by  $64.3 \pm 10.1\%$ . Thus, acute volume loading in the conscious baboons increased LV end-diastolic size and even stroke work substantially. However, preload dependency of LV  $dP/dt_{max}$  and the maximum velocity of myocardial fiber shortening was only encountered at low levels of LV preload.

## INTRODUCTION

The maximum rate of left ventricular (LV)<sup>1</sup> pressure rise,  $dP/dt_{max}$ , and the maximum velocity of myocardial fiber shortening, LV  $dD/dt_{max}$ , are widely used as indices of myocardial contractility. However, the utility of these indices is limited, due to sensitivity to changes in preload and afterload. It is generally recognized that LV  $dD/dt_{max}$  is more sensitive to changes in afterload (1), while LV  $dP/dt_{max}$  is thought to be more sensitive to changes in preload (2). The concept of preload dependency of LV  $dP/dt_{max}$  is based on numerous studies in isolated cardiac muscle (3–6), isolated hearts (6–11), anesthetized dogs (11–16) and even intact, conscious dogs (17), and man (18). The conceptual basis for the preload dependency of LV  $dP/dt_{max}$  is that an increase in preload activates the Frank-Starling mechanism, which in turn, increases LV  $dP/dt_{max}$ .

The objective of the present study was to examine the effects of acute increases in LV preload on cardiac performance in a model phylogenetically close to man, i.e., the intact, instrumented baboon. The specific hypothesis to be tested was to determine if an acute increase in preload would elicit the Frank-Starling mechanism, and secondly if under these conditions, LV  $dP/dt_{max}$  and LV  $dD/dt_{max}$  rose.

Dr. Zimpfer was a research fellow from Wien, Austria supported by a grant from the Max Kade Foundation. Address reprint requests to Dr. Vatner, New England Regional Primate Research Center.

Received for publication 31 August 1979 and in revised form 1 October 1980.

<sup>1</sup>Abbreviations used in this paper: LV, left ventricular; RF, radiofrequency.

## METHODS

### Implantation of Transducers

12 baboons (*papio anubis*), 20–26 kg, were tranquilized with ketamine hydrochloride, 10 mg/kg i.m., mechanically ventilated, and anesthetized using either halothane 1.5 vol% or pentobarbital, Na, 15 mg/kg. Through a left thoracotomy in the fifth intercostal space, a miniature pressure transducer (Konigsberg P22, Konigsberg Instruments, Inc., Pasadena, Calif.) was implanted in the left ventricle through a stab wound in the apex. A pair of ultrasonic transducers were implanted on opposing endocardial surfaces of the left ventricle. In six of these baboons another pair of ultrasonic transducers was implanted across the anterior LV wall, while in one baboon a third pair of ultrasonic transducers was implanted on opposing epicardial surfaces of the long axis of the LV wall. In all baboons Tygon catheters were implanted in the left atrium and the aorta. The transducer wires were run subcutaneously and buried in the interscapular area.

### Measurements

*Experiments in tranquilized baboons.* LV pressure was measured with the implanted miniature pressure gauges. These gauges were calibrated against a mercury manometer in vitro both before implantation and after their recovery from the animals. The LV pressure gauges were also cross-calibrated in vivo against the measurements of arterial and left atrial pressures. These latter pressures were measured using the implanted catheters and Statham Db strain gauge manometers (Statham Instruments, Inc., Oxnard, Calif.).

LV diameter and wall thickness were measured with an improved multichannel ultrasonic dimension gauge (19, 20). The instrument generates a voltage linearly proportional to the transit time of acoustic impulses traveling at the sonic velocity of  $\approx 1.5 \times 10^6$  mm/s between the 3-MHz piezoelectric crystals, thus giving a record of instantaneous internal LV diameter and wall thickness. At a constant room temperature the thermal drift of the instrument is minimal, i.e.,  $<0.01$  mm in 6 h. The frequency response is flat to 60 Hz. Any drift in the measurement system, in the instrument electronics, the data tape recorder, and the oscillograph that displayed data were eliminated during the experiment by periodic calibrations. This involved substitution of pulses of precisely known duration from a crystal-controlled pulse generator having a basic stability of 0.001%.

*Experiments in conscious, unrestrained baboons.* For these studies the equipment was carried by the animals in a backpack, tailored for baboons (Fig. 1). The backpack included telemetry systems that provided internal LV diameter measurements on a 220-MHz frequency modulated radiofrequency (RF) carrier, LV pressure measurements and a pilot tone of 62.5 kHz for synchronization of the receiving electronics on a second RF carrier of 90 MHz using FM-FM modulation. To accomplish the volume loading experiments in the conscious baboons, an RF interrogator system was used to activate a motor driven pump, which then emptied the contents of a 1,000-ml saline bag into the animal via a venous catheter that was previously implanted in the jugular vein, when the electronics was installed in the backpack before each experiment (Fig. 1). The interrogator system was a simple on-off switch controlled by a 10.7-MHz RF carrier, which was tone modulated to afford selectivity against inadvertent activation or inactivation of the electronics system.

## Protocols

*Experiments in tranquilized baboons.* 1–3 mo postoperatively, the animals were again tranquilized with ketamine, 10 mg/kg i.m. initially, and with supplemental doses (3 mg/kg i.m.) as required. Transducer leads were connected to the instrumentation as described above. Volume loading, by administering 1,000 ml of saline (37°C) over  $\sim 5$  min through intracaths (14 gauge, Deseret Pharmaceuticals, Sandy, Utah) placed into two peripheral veins, was accomplished on separate days, under the following conditions: (a) in 10 baboons, without any other intervention; (b) in 3 baboons, blood was infused; (c) in 4 baboons after  $\beta$ -adrenergic receptor blockade (propranolol, 1 mg/kg i.v.) tested with isoproterenol challenge, 0.5  $\mu$ g/kg, and (d) in 3 baboons after combined  $\beta$ -adrenergic and cholinergic (atropine, 0.2 mg/kg i.v.) blockades, tested with acetylcholine challenge, 40  $\mu$ g/kg; (e) in 6 baboons volume loading was carried out after a hemorrhage of 30 ml/kg. In four of these baboons the blood was reinfused first and then followed by 1,000 ml of saline. In two of these baboons the saline was administered first and then followed by the reinfusion of blood. In two animals the procedure was repeated on a separate day after  $\beta$ -adrenergic receptor blockade.

*Experiments in conscious baboons.* In six conscious unrestrained baboons sitting in a large outdoor enclosure 1,000 ml of saline was administered i.v. using the RF interrogator system described above (Fig. 1). It is important to note that sham volume loading experiments were carried out by activating the pump, but not infusing the saline.

### Data processing

The data were collected on magnetic tape for subsequent playback for data analysis. Parameters derived from the signals included LV  $dP/dt_{max}$  and LV  $dD/dt_{max}$ , i.e., the velocity of myocardial fiber shortening, using analog operational amplifiers. Expanded LV pressure was used to determine LV end-diastolic pressure. The frequency responses of differentiators was 700 and 140 Hz for  $dP/dt_{max}$  and  $dD/dt_{max}$ , respectively. Heart rate was derived using a cardi tachometer, triggered by the LV pressure pulse. LV wall stress was calculated for a thick-walled ellipsoidal model using the formulas suggested by Mirsky (21, 22). These formulas require knowledge of the relationship between the short and long axis of the left ventricle. This information was collected in one baboon, in which both measurements, i.e., LV long and short axis were recorded. During volume loading from the preload depressed base line, this relationship varied due to the assumption of a more spherical shape by the ventricle. During volume loading from the non-preload depressed base line, the ratio of the short to long axis remained  $\sim 0.62$ . Peak LV wall stress was calculated only for these latter experiments, and a value of 0.62 was used for the ratio of LV short to long axis. Peak LV wall stress was evaluated using a PDP-11/34 computer (Digital Equipment Corp., Marlboro, Mass.), which sampled LV pressure, minor axis LV diameter and LV wall thickness signals through an analog-to-digital converter and calculated the stress at 7-ms intervals. For the calculation of LV external cardiac work in tranquilized baboons, LV stroke volumes, derived from the LV end-diastolic and end-systolic diameter values assuming a spherical shape of the left ventricle, were multiplied by the mean arterial pressure. For the calculation of internal stroke work in the conscious baboons (since arterial pressure was not measured in these experiments) instantaneous LV pressure and diameter signals were digitized into the PDP 11/34 computer at 250 Hz, and the area inscribed by



### BACKPACK INSTRUMENTATION

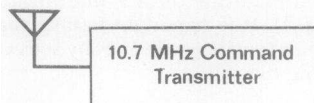
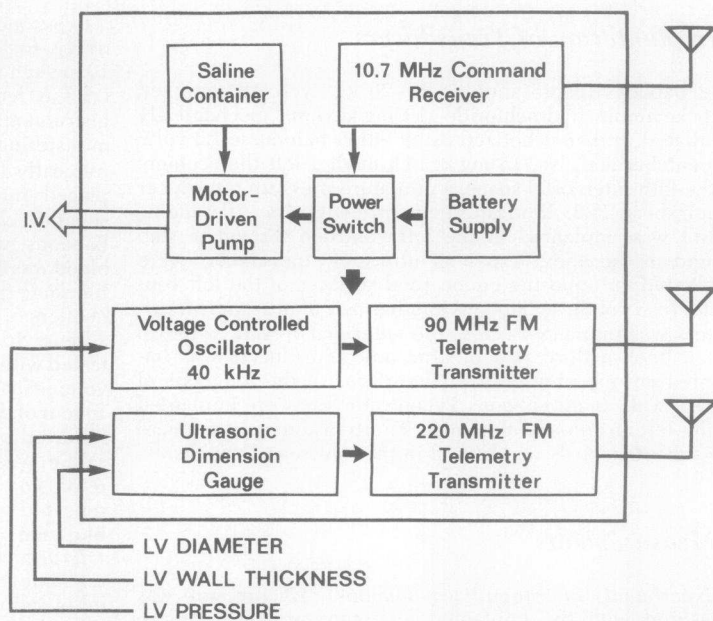

### DATA STATION INSTRUMENTATION

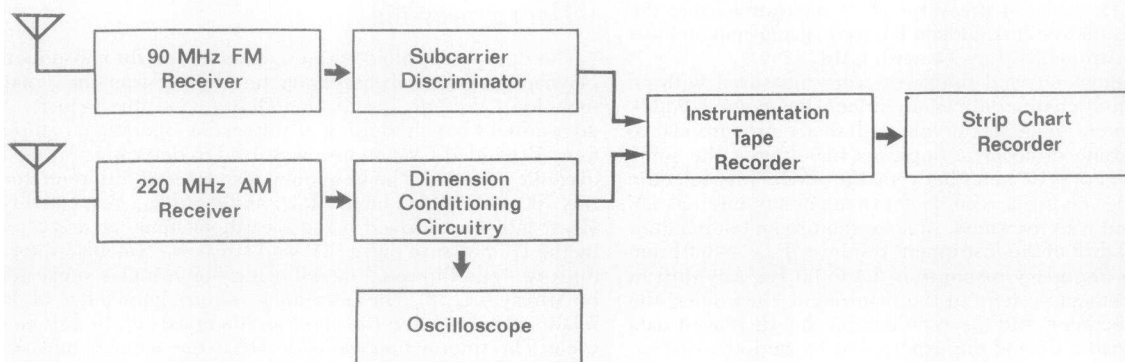

FIGURE 1 The instrumentation carried by the baboons in a backpack is shown schematically. The backpack contained the dual dimension/pressure telemetry apparatus plus batteries, which were used to power the system. An RF controlled interrogator was used to activate a motor driven pump to infuse 1,000 ml saline. The electronic instrumentation in the remote data station, used to receive and process the electronic signals, is schematically depicted at the bottom.

the LV pressure-diameter loop was computed as an index of work.

Results are expressed as mean  $\pm$  SEM. Significant changes from base line were determined using the paired *t* test, with the exception of the multiple (each 5-mm Hg increment in left atrial pressure) responses to volume loading in the tranquilized baboons. These latter data were compared to control using analysis of variance (23).

### RESULTS

Values listed are statistically significant, unless noted otherwise. Specific confidence values are in the tables and figures.

### *Volume loading in intact, tranquilized baboons*

The data for these experiments are tabulated for each 5-mm Hg increase in left atrial pressure that occurred with volume loading (Table I). Volume loading increased LV end-diastolic diameter by  $7.8 \pm 1.5\%$ , LV stroke shortening by  $22.6 \pm 3.8\%$ , and heart rate by  $36.1 \pm 4.4\%$ , whereas LV systolic pressure did not change significantly (Fig. 2). With volume loading the increases in LV end-diastolic diameter were associated with a progressive elevation in LV stroke work ( $37.5 \pm 7.8\%$ ) (Fig. 3). Mean arterial pressure and peak

TABLE I  
Effects of Volume Loading for Each 5-mm Hg Increment in Left Atrial Pressure

	n	Change from control with increase in left atrial pressure				
		Control	5	10	15	20
				mm Hg		
Heart rate, beats/min	11	87.4±3.7	9.9±1.5*	20.9±2.3*	27.2±2.4*	30.6±3.3*
LV systolic pressure, mm Hg	11	137.7±4.0	-0.6±1.0	-1.3±1.5	-4.0±3.2	-4.9±3.2
LV end-diastolic pressure, mm Hg	11	9.3±0.8	6.3±0.6*	12.9±1.3*	19.1±1.9*	23.7±2.6*
LV end-diastolic diameter, mm	11	40.0±1.5	1.5±0.3*	2.3±0.5*	2.6±0.5*	3.0±0.5*
LV end-systolic diameter, mm	11	29.8±2.7	0.6±0.2	0.7±0.2	0.7±0.3	0.9±0.4*
LV stroke shortening, mm	11	10.2±1.7	1.0±0.2*	1.5±0.4*	1.8±0.4*	2.0±0.3*
LV end-diastolic wall thickness, mm	6	10.6±0.8	0.0±0.0	0.0±0.1	0.1±0.1	0.1±0.1
LV end-systolic wall thickness, mm	6	14.2±0.7	0.2±0.1	0.4±0.1*	0.5±0.1*	0.7±0.2*
LV stroke wall thickening, mm	6	3.6±1.0	0.2±0.1*	0.4±0.1*	0.5±0.2*	0.6±0.2*
LV $dP/dt_{max}$ , mm Hg/s	11	2,357±235	-134±57	-122±59	-42±62	-135±115
LV $dD/dt_{max}$ , mm/s	11	57.4±3.4	0.6±1.1	0.3±1.2	1.8±1.7	1.2±2.0
Mean arterial pressure, mm Hg	11	108.1±5.7	0.5±0.6	1.3±1.4	-0.3±2.6	-2.4±3.4
LV stroke work, g·cm	11	2,600±210	419±67*	703±135*	779±140*	838±127*
LV wall stress, g/cm <sup>2</sup>	6	243±71	6.6±5.2	1.0±5.9	-0.3±7.7	-8.4±12

\* Change from control significant,  $P < 0.01$ .

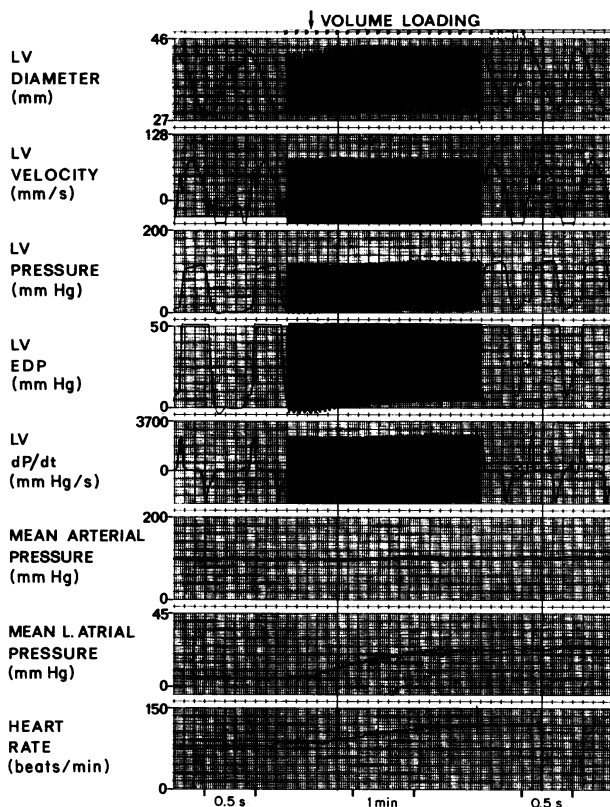

FIGURE 2 The effects of volume loading are shown on measurements of LV diameter, velocity of fiber shortening ( $dD/dt$ ), pressure, end-diastolic pressure,  $dP/dt$ , mean arterial pressure, mean left atrial pressure and heart rate in baboon tranquilized with ketamine. Volume loading consistently increased LV end-diastolic diameter, did not affect mean arterial pressure, and failed to increase either LV  $dP/dt$  or  $dD/dt$ .

LV wall stress did not change significantly despite the marked preload stress (Fig. 3). Acute volume loading with saline also failed to elicit significant changes in LV  $dP/dt_{max}$ , and LV  $dD/dt_{max}$  (Fig. 4). In the baboons given blood instead of saline, a similar pattern was observed. Arterial blood gases were analyzed using a radiometer acid-base analyzer (PHM 71 MK2) and blood microsystem (BMS 3 MK3) (Radiometer Co., Copenhagen, Denmark). In experiments with saline, infusion arterial  $pO_2$  ( $78 \pm 3.0$ ),  $pCO_2$  ( $39 \pm 1.7$ ), and pH (7.42) did not change significantly, whereas hematocrit fell from  $37 \pm 1.2$  to  $29 \pm 1.3$ . In experiments with blood infusion, neither arterial blood gases nor hematocrit changed significantly.

**Autonomic blockades.** Control values after  $\beta$ -adrenergic receptor blockade with propranolol are noted in Table II.

After  $\beta$ -adrenergic receptor blockade, volume loading increased LV end-diastolic pressure ( $187.0 \pm 14.1\%$ ), LV end-diastolic diameter ( $2.0 \pm 0.3\%$ ), heart rate ( $22.5 \pm 7.6\%$ ), LV stroke shortening ( $15.7 \pm 3.5\%$ ) and stroke work ( $15.9 \pm 4.4\%$ ) (Fig. 5), while mean arterial pressure, LV  $dP/dt_{max}$  and LV  $dD/dt_{max}$  did not change (Fig. 5). After combined  $\beta$ -adrenergic and cholinergic blockades, when heart rate remained constant with acute elevation in LV preload, volume loading still failed to elicit increases in LV  $dP/dt_{max}$  and LV  $dD/dt_{max}$ .

**Depressed preload.** Preload was depressed by hemorrhage, 30 ml/kg. Volume loading in the presence of depressed preload increased markedly LV end-diastolic diameter ( $37.0 \pm 8.1\%$  from  $28.6 \pm 2.5$  mm), LV stroke shortening ( $185.2 \pm 42.0\%$  from  $2.8 \pm 0.3$  mm), and LV stroke work ( $1,176 \pm 379\%$  from  $207 \pm 54$  g·cm). In these experiments LV  $dP/dt_{max}$  rose significantly (Fig. 6),

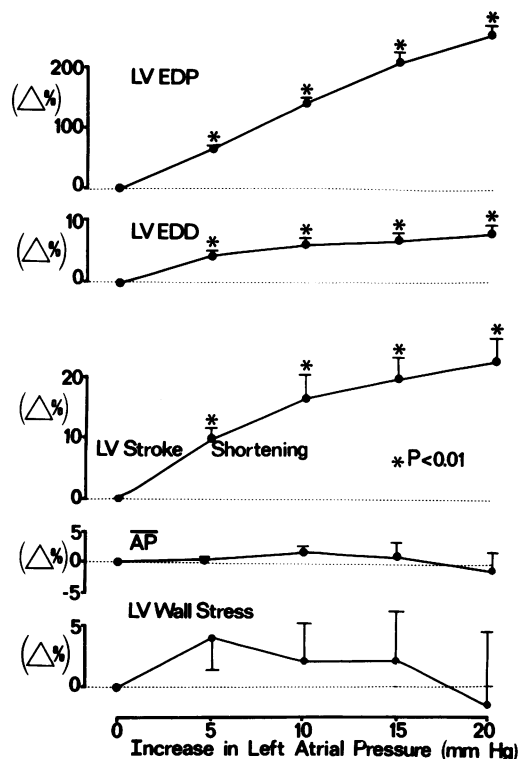

FIGURE 3 The average  $\pm$  SEM percent changes in LV end-diastolic pressure (EDP), LV end-diastolic diameter (EDD), LV stroke shortening, mean arterial pressure ( $\bar{A}P$ ), and peak LV wall stress are shown for responses to volume loading in tranquilized baboons. Significant changes are noted by asterisks. Volume loading elicited the Frank-Starling mechanism, i.e., it increased LV end-diastolic diameter, stroke shortening and stroke work, but failed to alter afterload significantly, i.e. either mean arterial pressure or peak LV wall stress.

i.e. by  $92.7 \pm 18.5\%$  from  $1,360 \pm 130$  mm Hg/s. LV- $dD/dt_{max}$  rose by  $64.3 \pm 10.1$  from a control of  $58.0 \pm 3.6$  mm/s. Reinfusion from the depressed preload state after  $\beta$ -adrenergic blockade still resulted in increases in LV  $dP/dt_{max}$  of 56 and 100% in the two experiments conducted.

#### Volume loading in conscious, unrestrained baboons (Fig. 7)

Base-line values for volume loading are included in Table III and Fig. 7.

When the mechanism for volume loading was activated, but saline was not infused, effects on cardiovascular dynamics were not observed. However, volume loading increased LV end-diastolic pressure by  $196 \pm 41\%$ , LV end-diastolic diameter by  $13.9 \pm 2.1\%$ , heart rate by  $41.3 \pm 9.9\%$ , LV stroke work by  $42.8 \pm 7.4\%$ , while LV

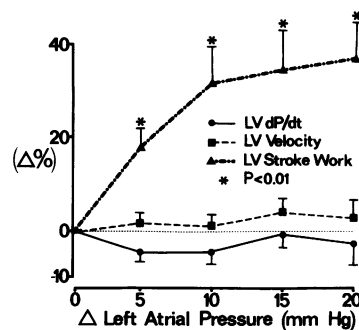

FIGURE 4 The average  $\pm$  SEM percent changes in LV stroke work ( $\blacktriangle$ ), LV  $dD/dt_{max}$  ( $\blacksquare$ ), and LV  $dP/dt_{max}$  ( $\bullet$ ) are shown for the tranquilized baboons in response to volume loading for each 5-mm Hg increment in left atrial pressure. Significant changes from control are noted by asterisks. Volume loading increased stroke work substantially but failed to alter either LV  $dP/dt_{max}$  or the maximum velocity of myocardial fiber shortening.

systolic pressure was not changed significantly. Despite the relatively large increases in LV end-diastolic diameter and stroke work, which occurred because these experiments were conducted in baboons in the upright posture, LV  $dP/dt_{max}$  and the velocity of myocardial fiber shortening (LV  $dD/dt_{max}$ ) failed to increase.

## DISCUSSION

The maximum rate of pressure rise in the left ventricle,  $dP/dt_{max}$ , could be extremely useful as an index of myocardial contractility in man and experimental animals, if it was not suspected of being preload dependent (2). Studies demonstrating an influence of preload on LV  $dP/dt_{max}$ , have been conducted in isolated cardiac muscle (3-6), isolated hearts (6-11), intact anesthetized animals (11-16), conscious animals (17), and man (18). More recently, results from studies in man have

TABLE II  
Base Line Values after  $\beta$ -Adrenergic Blockade in Four Intact, Tranquilized Baboons

Heart rate, beats/min	90.0 $\pm$ 1.0
LV systolic pressure, mm Hg	137.3 $\pm$ 5.9
LV end-diastolic pressure, mm Hg	10.8 $\pm$ 0.9
LV end-diastolic diameter, mm	41.7 $\pm$ 1.5
LV end-systolic diameter, mm	34.6 $\pm$ 1.4
LV stroke shortening, mm	7.2 $\pm$ 0.9
LV $dP/dt_{max}$ , mm Hg/s	2,367 $\pm$ 325
LV $dD/dt_{max}$ , mm/s	50.3 $\pm$ 4.7
Mean arterial pressure, mm Hg	100.3 $\pm$ 5.6
LV stroke work, g $\cdot$ cm	2,217 $\pm$ 279

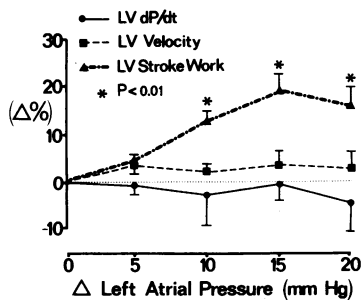

FIGURE 5 The average  $\pm$ SEM percent changes in LV stroke work ( $\blacktriangle$ ), LV  $dD/dt_{max}$  ( $\blacksquare$ ), and  $dP/dt_{max}$  ( $\bullet$ ) are shown for the tranquilized baboons in response to volume loading after  $\beta$ -adrenergic blockade. Significant changes from control are noted by asterisks. After  $\beta$ -adrenergic blockade volume loading still increased stroke work and still failed to alter either LV  $dP/dt_{max}$  or LV  $dD/dt_{max}$ , indicating that reflex mechanisms were not masking the preload sensitivity of these indices.

questioned the concept of preload dependence of LV  $dP/dt_{max}$  (24–26). However, human studies are limited because of the inability to stress the left ventricle severely due to ethical considerations. For example, in the study of Quinones et al. (26) the volume load was 10–20% of that utilized in the present investigation, i.e., roughly one-third the volume was administered to patients with body mass roughly threefold larger than the baboons. On the other hand, studies in isolated cardiac muscle, isolated hearts and open-chest anes-

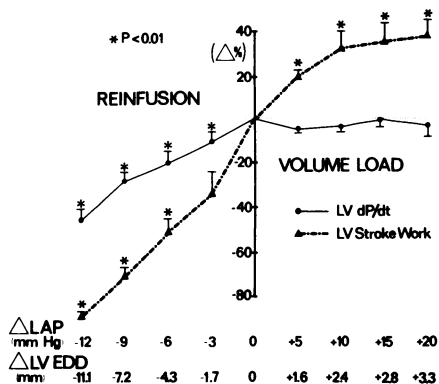

FIGURE 6 The average  $\pm$ SEM percent changes in stroke work ( $\blacktriangle$ ) and LV  $dP/dt_{max}$  ( $\bullet$ ) are compared with infusion of either blood or saline from the depressed preload state (left panel) and in the normal physiological state (right panel). The measurements are plotted against changes in both left atrial pressure (LAP) and LV end-diastolic diameter (LV EDD). Significant changes are indicated by the asterisks. In both situations increasing preload enhanced LV stroke work but only with depressed preload did LV  $dP/dt_{max}$  rise significantly with volume loading.

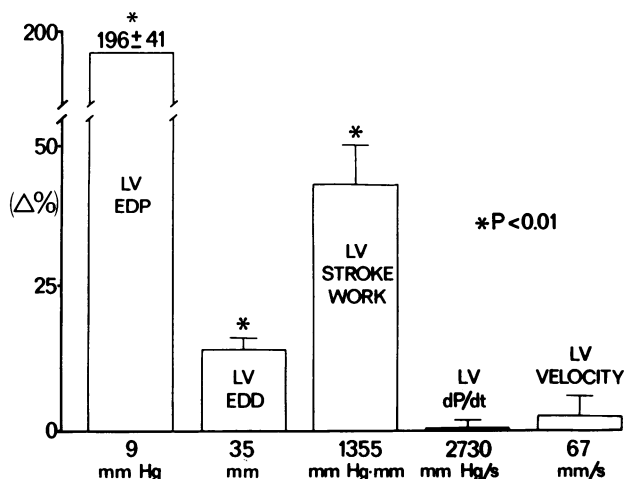

FIGURE 7 The average  $\pm$ SEM percent changes in response to acute volume loading for LV end-diastolic pressure (LV EDP), end-diastolic diameter (LV EDD) and stroke work,  $dP/dt_{max}$  and LV velocity of fiber shortening (LV  $dD/dt_{max}$ ) are shown for six conscious baboons studied in the upright posture. Control values prior to volume loading are shown at the base of the bars. Volume loading increased LV EDP markedly and also increased LV EDD and stroke work, but failed to alter LV  $dP/dt_{max}$  or LV  $dD/dt_{max}$  significantly.

thetized preparations can be criticized on the basis that they are unphysiological. Indeed, directionally opposite results are found when the effects of volume loading are examined in open-chest anesthetized and intact, conscious dogs (27). However, extrapolation from experiments in conscious dogs to man is limited by virtue of species difference. The present investigation attempts to overcome many of the above mentioned limitations in experimental design, by examining the control of cardiac performance in a primate model of man.

Since the mechanism for preload dependence of LV  $dP/dt_{max}$  and the maximum velocity of fiber shortening

TABLE III  
Base Line Values in Six Conscious, Unrestrained Baboons

Heart rate, beats/min	96.5 $\pm$ 6.3
LV systolic pressure, mm Hg	141.8 $\pm$ 3.8
LV end-diastolic pressure, mm Hg	9.4 $\pm$ 1.2
LV end-diastolic diameter, mm	35.0 $\pm$ 1.5
LV end-systolic diameter, mm	28.3 $\pm$ 1.8
LV stroke shortening, mm	6.7 $\pm$ 0.4
LV $dP/dt_{max}$ , mm Hg/s	2,726 $\pm$ 292
LV $dD/dt_{max}$ , mm/s	66.5 $\pm$ 1.8
LV stroke work, mm Hg $\cdot$ mm	1,355 $\pm$ 265

is thought to be related to the Frank-Starling mechanism, it was important to first determine whether the Frank-Starling mechanism could be demonstrated in the baboons. Volume loading in tranquilized baboons elicited increases in left atrial and LV end-diastolic pressures, LV end-diastolic diameter, stroke shortening, and external cardiac work, indicating that the Frank-Starling mechanism could be activated. The increases in LV end-diastolic diameter were relatively small, compared with increases in cardiac dimensions with volume loading in anesthetized animals with an open chest (27), but were slightly greater than those observed in conscious, reclining dogs, since reflex increases in cardiac rate, which oppose increases in LV end-diastolic dimensions, were less in the baboons than previously observed in dogs (27). Moreover, increases in LV stroke-shortening were greater in the baboons than previously observed in conscious dogs (27). In part this was due to the difference in effect on afterload; in baboons afterload did not rise, whereas in dogs the significant increases in afterload prevented increases in stroke-shortening. In contrast to both conscious and anesthetized dogs, despite the acute and distinct elevation in LV preload, LV  $dP/dt_{max}$ , and the maximum velocity of fiber shortening, LV  $dD/dt_{max}$ , failed to change significantly with volume loading in the baboon.

Many prior studies on this topic in either anesthetized (27) or conscious (17, 27) animals are limited by the fact that afterload also changes with volume loading. Serendipitously, in the baboon, acute volume loading does not result in a significant increase in afterload, whether this determinant of cardiac function is evaluated on the basis of mean arterial pressure measurement or of peak LV wall stress calculation. Thus, in the present investigation the conclusion that an increase in preload from base line levels is not associated with an increase in either LV  $dP/dt_{max}$  or LV  $dD/dt_{max}$  is not complicated by changes in afterload.

Volume loading experiments were also conducted with blood, suspecting that the hemodilution induced by saline, might skew the results. However, volume loading with blood elicited similar results, i.e., LV  $dP/dt_{max}$  and maximum velocity of myocardial fiber shortening failed to rise despite the increase in preload and activation of the Frank-Starling mechanism.

It was also conceivable that a reflex negative inotropic effect, mediated through either high or low pressure baroreceptors, attenuated the rise in LV  $dP/dt_{max}$  and LV  $dD/dt_{max}$  induced by an increase in preload. This is unlikely, since experiments either after  $\beta$ -adrenergic receptor blockade alone or after combined  $\beta$ -adrenergic and cholinergic blockades, failed to demonstrate an increase in LV  $dP/dt_{max}$  or LV  $dD/dt_{max}$  with volume loading.

It is important to note that heart rate rose with volume loading. This should not counter the conclusions of the present study, since tachycardia, per se, should if anything increase LV  $dP/dt_{max}$  and LV  $dD/dt_{max}$  through the Bowditch mechanism. However, in these experiments, as was observed previously in conscious dogs, the Bowditch mechanism appears to be of little importance in controlling myocardial contractility (28). The data in the present study were not affected significantly by the modest rise in heart rate. Furthermore, after combined  $\beta$ -adrenergic and cholinergic blockades, acute volume loading was neither associated with an increase in heart rate nor increases in LV  $dP/dt_{max}$  or LV  $dD/dt_{max}$ .

It was felt particularly important to examine the response to volume loading in conscious, unrestrained baboons, since tranquilization could affect the control of cardiac performance. To do this, a 1,000-ml bag of saline was attached to a venous line and a motor driven pump, carried in the backpack of the animal. In the conscious, unrestrained baboons, acute volume loading elicited a similar response to that observed in the tranquilized animals, i.e. with an increase in preload, LV end-diastolic diameter and stroke work rose, indicating that the Frank-Starling mechanism could be activated. The increases in LV end-diastolic diameter were larger in the conscious as opposed to the tranquilized baboons because the conscious, unrestrained baboons were sitting and not reclining, and thus had a slightly depressed preload due to the different posture. Despite this larger increase in preload, LV  $dP/dt_{max}$  and LV  $dD/dt_{max}$  failed to change significantly. It is important to note that no hemodynamic changes were observed when the system was activated but saline was not infused.

It may be speculated that many prior experiments in lower species, particularly those with an open chest, were conducted with the preload artificially depressed. Therefore, baboons were also studied on separate days when LV preload was artificially depressed by acute hypovolemia. Acute hemorrhage was followed by reinfusion of the blood or by infusion of saline. Under these conditions, i.e., with depressed LV preload, a striking increase in LV stroke work was associated with a pronounced preload dependency of LV  $dP/dt_{max}$  and LV  $dD/dt_{max}$ . It is important to note that at very low arterial pressure levels as occurs with hemorrhage, increases in LV  $dP/dt_{max}$  with reinfusion do not only reflect changes in preload, but also are associated with increases in afterload. The increases in LV  $dP/dt_{max}$  and LV  $dD/dt_{max}$  with volume loading in the presence of depressed preload were not due to reflex mechanisms, since they still were observed after  $\beta$ -adrenergic blockade.

It is important to note that preload (LV end-diastolic diameter) rose significantly more for a given increment



in LV end-diastolic pressure in the experiments conducted from a depressed preload (left side, Fig. 6) as compared with those experiments conducted from the normal base line (right side, Fig. 6). It is conceivable that the greater preload stress, per se, could explain why LV  $dP/dt_{max}$  rose significantly more from the preload-depressed base line. In order to examine this possibility, responses of LV  $dP/dt_{max}$  were normalized for changes in LV end-diastolic diameter. The entire increase in LV end-diastolic diameter that was observed with volume loading from the normal base line was 3.3 mm (Fig. 6, right side). This increase in LV end-diastolic diameter was not significantly different from the four individual increases in LV end-diastolic diameter, which varied from 1.7 to 3.9 mm, when volume loading was carried out from the preload-depressed base line (Fig. 6, left side). However, each of these four increases in LV  $dP/dt_{max}$ , that occurred with 3 mm Hg increments in left atrial pressure with volume loading in the presence of depressed preload, were significantly greater ( $P < 0.05$ ) than what was observed with the entire increase in preload from the normal base line.

In conclusion, in both conscious, unrestrained and intact tranquilized baboons, volume loading with blood or saline elicited the Frank-Starling mechanism without affecting afterload substantially. The acute elevation of LV preload from physiological base line levels failed to augment either LV  $dP/dt_{max}$  or the maximum velocity of myocardial fiber shortening. On the other hand, in accordance with experiments in lower species with artificially depressed preload levels, activation of the Frank-Starling mechanism after volume depletion was associated with substantial increases in LV  $dP/dt_{max}$  and LV  $dD/dt_{max}$ . The results of the present investigation indicating insensitivity of LV  $dP/dt_{max}$  to increases in preload, suggest that this index, also because of its relative insensitivity to changes in afterload and to moderate changes in heart rate, should be useful in human as well as animal studies to define myocardial contractility as long as base line preload is not depressed. With this in mind it is important to note that the majority of patients studied at cardiac catheterization exhibit normal or elevated levels of preload.

#### ACKNOWLEDGMENTS

The authors gratefully acknowledge the help of Stan Letovsky for the computer programming, A. Sherman for the engineering assistance, and Ayerst Laboratories, New York for the generous supply of propranolol.

Supported in part by U. S. Public Health Services grants HL 15416, HL 26215, HL 20552, and National Aeronautics and Space Administration grant NSG 2136.

#### REFERENCES

- Braunwald, E., and J. Ross, Jr. 1979. Control of cardiac performance. In *Handbook of Physiology*, Section 2: The Cardiovascular System. R. M. Berne, N. Sperelakis, editors. American Physiology Society, Bethesda, Md. 1: 553-580.
- Sonnenblick E. H., and J. E. Strobeck. 1977. Derived indexes of ventricular and myocardial function. *N. Engl. J. Med.* **296**: 978-982.
- Abbott, B. C., and W. F. H. M. Mommaerts. 1959. A study of inotropic mechanisms in the papillary muscle preparation. *J. Gen. Physiol.* **42**: 533-551.
- Parmley, W. W., and L. Chuck. 1973. Length-dependent changes in myocardial contractile state. *Am. J. Physiol.* **224**: 1195-1199.
- Pollack, G. H. 1970. Maximum velocity as an index of contractility in cardiac muscle. *Circ. Res.* **26**: 111-127.
- Siegel, J. H., and E. H. Sonnenblick. 1963. Isometric-tension relationships as an index of myocardial contractility. *Circ. Res.* **12**: 597-610.
- Schmidt, H. D., H. Hoppe, and W. Schneider. 1973. Usefulness of some pressure velocity parameters for evaluation of left ventricular contractility. *Verh. Dtsch. Ges. Kreislaufforsch.* **39**: 151-156.
- Schmidt, H. D., and H. Hoppe. 1978. Preload dependence of  $dP/dt_{max}$ ,  $V_{CE_{max}}$  and calculated  $V_{max}$  compared to the inotropic sensitivity of these indices of cardiac contractility. *Basic Res. Cardiol.* **73**: 380-393.
- Schmidt, H. D., and H. Hoppe. 1978. Influence of the contractile state of the heart on the preload dependence of the maximal rate of intraventricular pressure rise  $dP/dt_{max}$ . *Cardiology.* **63**: 112-125.
- Burns, J. W., J. W. Covell, and J. Ross, Jr. 1973. Mechanics of isotonic left ventricular contractions. *Am. J. Physiol.* **224**: 725-732.
- Van den Bos, G. C., G. Elzinga, N. Westerhof, and M. I. M. Noble. 1973. Problems in the use of indices of myocardial contractility. *Cardiovasc. Res.* **7**: 834-848.
- Galosy, R. A., J. H. Mitchell, J. M. Atkins, and J. Reisch. 1978. Sympathetic stimulation, hemodynamic factors, and indices of cardiac inotropic state. *Am. J. Physiol.* **234**: H562-H566.
- Reeves, T. J., L. L. Hefner, W. B. Jones, C. Coghlan, G. Prieto, and J. Carroll. 1960. The hemodynamic determinants of the rate of change in pressure in the left ventricle during isometric contraction. *Am. Heart J.* **60**: 745-761.
- Morgenstern, C., G. Arnold, U. Höljes, and W. Lochner. 1970. Die Druckanstiegsgeschwindigkeit im linken Ventrikel als Maß für die Kontraktilität unter verschiedenen hämodynamischen Bedingungen. *Pfluegers Arch. Eur. Physiol.* **315**: 173-186.
- Veragut, U. P., and H. P. Krayenbühl. 1965. Estimation and quantification of myocardial contractility in the closed-chest dog. *Cardiologia.* **47**: 96-112.
- Wallace, A. G., N. S. Skinner, Jr., and J.H. Mitchell. 1963. Hemodynamic determinants of the maximal rate of rise of left ventricular pressure. *Am. J. Physiol.* **205**: 30-36.
- Mahler, F., J. Ross, Jr., R. A. O'Rourke, and J. W. Covell. 1975. Effects of changes in preload, afterload and inotropic state on ejection and isovolumic phase measures of contractility in the conscious dog. *Am. J. Cardiol.* **35**: 626-634.
- Gleason, W. L., and E. Braunwald. 1962. Studies on the first derivative of the ventricular pressure pulse in man. *J. Clin. Invest.* **41**: 80-91.
- Patrick, T. A., S. F. Vatner, W. S. Kemper, and D. Franklin. 1974. Telemetry of left ventricular diameter and pressure

- measurements from unrestrained animals. *J. Appl. Physiol.* **37**: 276–281.
20. Pagani, M., S. F. Vatner, H. Baig, D. L. Franklin, T. Patrick, W. T. Manders, P. Quinn, and A. Sherman. 1978. Measurement of multiple simultaneous small dimensions and study of arterial pressure-dimension relations in conscious animals. *Am. J. Physiol.* **4**: H610–H617.
  21. Mirsky, I. 1969. Left ventricular stresses in the intact, human heart. *Biophys. J.* **9**: 189–208.
  22. Mirsky, I., and J. S. Rankin. 1979. The effects of geometry, elasticity, and external pressures on the diastolic pressure-volume and stiffness-stress relations. *Circ. Res.* **44**: 601–611.
  23. Armitage, P. 1974. *Statistical Methods in Medical Research*. Blackwell Scientific Press, Ltd., Oxford.
  24. Rankin, L. S., S. Moos, and W. Grossman. 1975. Alterations in preload and ejection phase indices of left ventricular performance. *Circulation.* **51**: 910–915.
  25. Grossman, W., F. Haynes, J. A., Paraskos, S. Saltz, J. E. Dalen, and L. Dexter. 1972. Alterations in preload and myocardial mechanics in the dog and in man. *Circ. Res.* **31**: 83–94.
  26. Quinones, M. A., W. H. Gaasch, and J. K. Alexander. 1976. Influence of acute changes in preload, afterload, contractile state and heart rate on ejection and isovolumic indices of myocardial contractility in man. *Circulation.* **53**: 293–302.
  27. Boettcher, D. H., S. F. Vatner, G. R. Heyndrickx, and E. Braunwald. 1978. Extent of utilization of the Frank-Starling mechanism in conscious dogs. *Am. J. Physiol.* **234**: H338–H345.
  28. Higgins, C. B., S. F. Vatner, D. Franklin, and E. Braunwald. 1973. Extent of regulation of the heart's contractile state in the conscious dog by alteration in the frequency of contraction. *J. Clin. Invest.* **52**: 1187–1194.